

ENTRANCES

REBCO'S IN FRONT!!!



REBCO

1171 - 1225 Madison Avenue, P.O. Box 2248, Paterson, NJ 07509 - 2248 INCORPORATED

NJ 973 - 684 - 0200 • NY 212 - 736 - 6435
Outside NY/NJ 800 - 777 - 0787 • FAX 973 - 684 - 0118

e-mail: sales@REBCOinc.com • www.REBCOinc.com

TERMS & CONDITIONS OF SALE

FOR REBCO STOCK LENGTHS, WINDOWS AND ENTRANCES

Unless otherwise agreed in writing, all proposals, quotations and sales are made upon the following terms and conditions. No modifications, changes, additions, deletions or suspensions will be binding upon REBCO. Any orders accepted by REBCO are conditioned upon the following terms and conditions of sale:

ORDER ACCEPTANCE AND DELIVERY

1. When accepted by REBCO, orders become binding contracts and any changes and/or cancellations are subject to charges for costs incurred.
2. In cases of strikes, fires, floods, snows, accidents, common carrier delays, failure of outside vendors to deliver materials or parts, and other problems beyond our control, REBCO assumes no responsibility nor economic liability for failure to meet planned delivery schedule. Every effort will be made to return to schedule as soon as possible following the event.
3. Delivery dates indicated in confirmation of order are approximate only and shall not subject the Company to any economic liability for failure to meet the approximate shipping schedule.
4. Title to materials sold shall pass to the buyer on delivery to common carrier at point of shipment, however, the seller shall retain a lien for payment on the materials so sold until the purchase price has been paid in full.
5. Back orders for material omitted from the original shipment because of shortage of stock or other conditions beyond our control, shall be on the same terms and conditions of sale as if it were included in the original shipment.

PRICES AND QUOTATIONS

1. Prices are subject to change without notice. In the event of a price change, orders on hand shall be invoiced at the prices in effect at the time orders are shipped.
2. Prices quoted herein are List Prices, unless otherwise specified, and are subject to discount prevailing at the time orders were received.
3. Prices are F.O.B. point of manufacture. No allowances shall be made for transportation charges.
4. Quotations unless otherwise noted are subject to placement of orders within 30 days. Changes in prices that have been made for materials included in quotations shall become effective at the end of the 30 day period.
5. REBCO Inc. will not be responsible for any losses sustained by purchasers through the use of an obsolete price list or pages thereof.
6. Taxes or other government charges upon the manufacture, sale or shipment of materials listed herein as imposed by Federal, State or Municipal authority shall be added to the price to be paid by the purchaser.

PAYMENT

1. Other than for cash or C.O.D. accounts, terms of sale are net 30 days.
2. Past due accounts shall be subject to an interest charge of 1-1/5% per month on the unpaid balance.
3. Back charges for repairs or alterations will not be allowed unless specifically accepted in advance in writing by REBCO, Inc. We shall not assume backcharges for labor or materials required on the job site due to inaccuracies caused by the use of templates for cut-outs or dealer approved drawings and dimensions.
4. Cancellations of custom work will not be accepted without charges for labor, materials and related expenses.

CLAIMS

1. Purchaser shall immediately check all materials on receipt and any damages, defects, shortages or improper character shall be reported to REBCO Inc. in writing within five days of receipt of said material. Failure to so notify shall constitute waiver of any claim against REBCO Inc. for such conditions.
2. In no event shall REBCO Inc. be responsible for any damage arising from the use of damaged, defective or improper character of materials.

3. Any material deemed defective which is covered under our warranty shall be repaired or replaced under the terms of a warranty. Labor or other expenditure incurred by the purchaser or any other party in consequence of such a material defect cannot be claimed.

RETURNED MATERIAL

1. Returned material shall not be accepted unless previously authorized, and documented on a Return Goods Report ticket. The returned material must be accompanied by the Return Goods Report. Material must be returned within 30 days from receipt of ticket.
2. Credits will not be allowed for unclean and improperly wrapped material or material which has been cut or damaged.
3. Returned material shall be subject to Company inspection. Credit for saleable material shall be allowed at the invoiced price less a 15% minimum handling charge.
4. Transportation costs on returned material shall be prepaid by the buyer.

GENERAL

1. Unless otherwise specified, entrances will be provided with M.S. lock, 2 cylinders, standard push/pull, flush bolts on inactive doors, glazing pocket for 1/4" glass, and 1-3/4" x 4-1/2" framing.
2. In an effort to maintain the most current styles and latest design innovations, we may find it necessary to change details without notice.
3. Special hardware may require modifications to our standard products which can change the look of a product, be it windows, doors or entrances. If a particular style is to be maintained please notify us.
4. Hardware furnished by others must be in the plant before an order is placed into fabrication. A delay in the timely receipt of purchaser supplied hardware will delay accordingly, shipment of an order. Expediting hardware will be the responsibility of the purchaser. Any expense incurred to modify and/or to repair hardware which is inaccurate or defective will be charged to the buyer. Any defects or inaccuracies related to hardware by others will be resolved by the purchaser and the hardware supplier. It is the responsibility of the purchaser to ascertain whether or not the custom hardware to be provided can be used with the entrances being ordered.
5. Ordering the materials, hardware and entrances acceptable by local building and fire codes is the responsibility of the purchaser.
6. REBCO, Inc. is not responsible for typographic errors or errors of omission in this catalog.

PURCHASER'S RESPONSIBILITIES

1. The purchaser accepts responsibility for ordering material which will conform to all of the local, state and federal building codes as well as to A.D.A. standards.
2. All materials shall be installed by experienced mechanics and shall conform to the highest standards of the industry, i.e. all materials shall be set in their proper locations, plumb, level, square, clean and be provided a solid anchoring surface.
3. Fasteners, where exposed, shall be aluminum, stainless steel or plated steel in accordance with ASTM A164. Perimeter anchors shall be aluminum or steel providing the steel is properly isolated from the aluminum. Where aluminum sections are placed in contact with steel, concrete, plaster, or other dissimilar materials, the entire aluminum surface of contact shall be back painted with a heavy coat of approved bituminous paint.
4. All joints between the aluminum framing and the wood or masonry shall be sealed in order to secure a watertight installation. *NOTE: REBCO, Inc. does not normally provide structural support of the framing system, trim, and/or metal sub sills. REBCO may at its option and if requested to do so, provide one or more of these options if they are specified by the purchaser.*
5. The purchaser shall protect the aluminum entrance, window and/or frame material and finish against damage from construction activities and harmful substances. Upon completion of construction, the purchaser and/or general contractor shall be responsible for cleaning the aluminum with plain water containing mild soap or detergent or a petroleum product such as white gasoline, kerosene, or distillate. No abrasive agent shall be used.

STANDARD UNIT SPECIFICATIONS:

- Narrow N.S. Door with 1³/₄" x 4¹/₂" framing.
- N.S. Door comes complete with M.S. Lock, cylinders both sides, or flush bolts on the inactive leaf of a pair and standard push/pull hardware.
- Standard doors are prepped for 1/4" glazing.
1" glazing prep on doors is available upon request only.
- Frames are complete with door stops, glazing pockets in transom area, and exterior pockets in jamb.
- 5" Aluminum Threshold is standard.
- Pair of butts or top & bottom pivots.
- No glass or closers included. (See p. 20 for closer).

ENTRANCES

Butt Hung (B) or Offset Pivots (P)

The best narrow stile door on the market!

REBCO's main door members have a wall thickness of .125" and stop thickness of .050". Joints are mechanically fastened and then 100% deep penetration welded on unexposed surfaces. Standard doors are complete with Adams Rite deadlock cylinders on both sides, or flush bolts in the inactive leaf of pair of doors, and our standard push & pulls.

Type	Part Number	Nominal Door Size	Non-thermal Framing	Frame Size	Glazing Pocket for	(-1) Clear	(-2) Dk. Bronze	(-4) White	(-5) Black
BUTT HUNG	B-ED-1-	3'0" x 7'0"	1 ³ / ₄ " x 4 ¹ / ₂ "	39 ¹ / ₂ " x 85 ³ / ₄ "	1/4"				
	B-ED-2-	3'6" x 7'0"							
BUTT HUNG	1 B-ED-1-	3'0" x 7'0"	2" x 4 ¹ / ₂ "	40" x 86"	1"				
	1 B-ED-2-	3'6" x 7'0"							
OFFSET PIVOT	P-ED-1-	3'0" x 7'0"	1 ³ / ₄ " x 4 ¹ / ₂ "	39 ¹ / ₂ " x 85 ³ / ₄ "	1/4"				
	P-ED-2-	3'6" x 7'0"							
OFFSET PIVOT	1 P-ED-1-	3'0" x 7'0"	2" x 4 ¹ / ₂ "	40" x 86"	1"				
	1 P-ED-2-	3'6" x 7'0"							

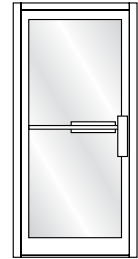

Type	Part Number	Nominal Door Size	Non-thermal Framing	Frame Size	Glazing Pocket for	(-1) Clear	(-2) Dk. Bronze	(-4) White	(-5) Black
BUTT HUNG	B-EDD-1-	6'0" x 7'0"	1 ³ / ₄ " x 4 ¹ / ₂ "	75 ¹ / ₂ " x 85 ³ / ₄ "	1/4"				
	B-EDD-2-	7'0" x 7'0"							
BUTT HUNG	1 B-EDD-1-	6'0" x 7'0"	2" x 4 ¹ / ₂ "	76" x 86"	1"				
	1 B-EDD-2-	7'0" x 7'0"							
OFFSET PIVOT	P-EDD-1-	6'0" x 7'0"	1 ³ / ₄ " x 4 ¹ / ₂ "	75 ¹ / ₂ " x 85 ³ / ₄ "	1/4"				
	P-EDD-2-	7'0" x 7'0"							
OFFSET PIVOT	1 P-EDD-1-	6'0" x 7'0"	2" x 4 ¹ / ₂ "	76" x 86"	1"				
	1 P-EDD-2-	7'0" x 7'0"							

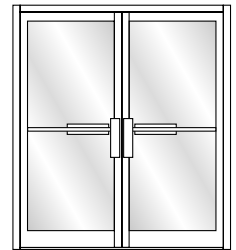

Type	Part Number	Nominal Door Size	Non-thermal Framing	Frame Size	Glazing Pocket for	(-1) Clear	(-2) Dk. Bronze	(-4) White	(-5) Black
BUTT HUNG	B-ETD-1-	3'0" x 7'0"	1 ³ / ₄ " x 4 ¹ / ₂ "	39 ¹ / ₂ " x 120"	1/4"				
	B-ETD-2-	3'6" x 7'0"							
BUTT HUNG	1 B-ETD-1-	3'0" x 7'0"	2" x 4 ¹ / ₂ "	40" x 120"	1"				
	1 B-ETD-2-	3'6" x 7'0"							
OFFSET PIVOT	P-ETD-1-	3'0" x 7'0"	1 ³ / ₄ " x 4 ¹ / ₂ "	39 ¹ / ₂ " x 120"	1/4"				
	P-ETD-2-	3'6" x 7'0"							
OFFSET PIVOT	1 P-ETD-1-	3'0" x 7'0"	2" x 4 ¹ / ₂ "	40" x 120"	1"				
	1 P-ETD-2-	3'6" x 7'0"							

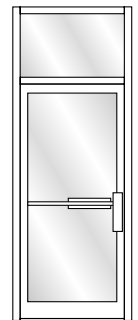

Type	Part Number	Nominal Door Size	Non-thermal Framing	Frame Size	Glazing Pocket for	(-1) Clear	(-2) Dk. Bronze	(-4) White	(-5) Black
BUTT HUNG	B-ETDD-1-	6'0" x 7'0"	1 ³ / ₄ " x 4 ¹ / ₂ "	75 ¹ / ₂ " x 120"	1/4"				
	B-ETDD-2-	7'0" x 7'0"							
BUTT HUNG	1 B-ETDD-1-	6'0" x 7'0"	2" x 4 ¹ / ₂ "	76" x 120"	1"				
	1 B-ETDD-2-	7'0" x 7'0"							
OFFSET PIVOT	P-ETDD-1-	6'0" x 7'0"	1 ³ / ₄ " x 4 ¹ / ₂ "	75 ¹ / ₂ " x 120"	1/4"				
	P-ETDD-2-	7'0" x 7'0"							
OFFSET PIVOT	1 P-ETDD-1-	6'0" x 7'0"	2" x 4 ¹ / ₂ "	76" x 120"	1"				
	1 P-ETDD-2-	7'0" x 7'0"							

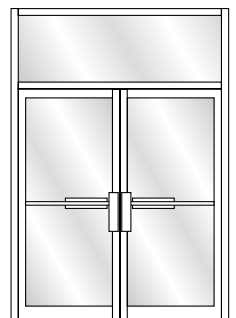

ENTRANCES

Center Hung (CH) Doors Double Acting

The best narrow stile door on the market!

REBCO's main members have a wall thickness of .125" and stop thickness of .050". Joints are mechanically fastened and then 100% deep penetration welded on unexposed surfaces.

STANDARD UNITS SHIP WITH:

- Narrow Stile Doors and 1³/₄" x 4¹/₂" Frame.
- Standard Push on both sides of door. (Push/Pull, or Pull/Pull will be provided instead, if requested.)
- Doors complete with MS lock, cylinders on both sides or flush bolts on the inactive leaf of a pair.
- Narrow stile doors prepped for 1/4" glass.
- 5" aluminum threshold.
- Top CH Pivot (Walking Beam) & Bottom Pivot (door and floor portion).
- No closer or glass included.

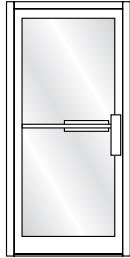

Type	Part Number	Nominal Door Size	Non-thermal Framing	Frame Size	Glazing Pocket for	(-1) Clear	(-2) Dk. Bronze	(-4) White	(-5) Black
CENTER HUNG PIVOT DOOR	CH-ED-1-	3'0" x 7'0"	1 ³ / ₄ " x 4 ¹ / ₂ "	39 ¹ / ₂ " x 85 ³ / ₄ "	1/4"				
	CH-ED-2-	3'6" x 7'0"		45 ¹ / ₂ " x 85 ³ / ₄ "					
	1 CH-ED-1-	3'0" x 7'0"	2" x 4 ¹ / ₂ "	40" x 86"	1"				
	1 CH-ED-2-	3'6" x 7'0"		46" x 86"					

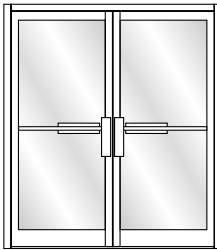

Type	Part Number	Nominal Door Size	Non-thermal Framing	Frame Size	Glazing Pocket for	(-1) Clear	(-2) Dk. Bronze	(-4) White	(-5) Black
CENTER HUNG PIVOT DOOR	CH-EDD-1-	6'0" x 7'0"	1 ³ / ₄ " x 4 ¹ / ₂ "	75 ¹ / ₂ " x 85 ³ / ₄ "	1/4"				
	CH-EDD-2-	7'0" x 7'0"		87 ¹ / ₂ " x 85 ³ / ₄ "					
	1 CH-EDD-1-	6'0" x 7'0"	2" x 4 ¹ / ₂ "	76" x 86"	1"				
	1 CH-EDD-2-	7'0" x 7'0"		88" x 86"					

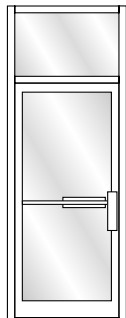

Type	Part Number	Nominal Door Size	Non-thermal Framing	Frame Size	Glazing Pocket for	(-1) Clear	(-2) Dk. Bronze	(-4) White	(-5) Black
CENTER HUNG PIVOT DOOR	CH-ETD-1-	3'0" x 7'0"	1 ³ / ₄ " x 4 ¹ / ₂ "	39 ¹ / ₂ " x 120"	1/4"				
	CH-ETD-2-	3'6" x 7'0"		45 ¹ / ₂ " x 120"					
	1 CH-ETD-1-	3'0" x 7'0"	2" x 4 ¹ / ₂ "	40" x 120"	1"				
	1 CH-ETD-2-	3'6" x 7'0"		46" x 120"					

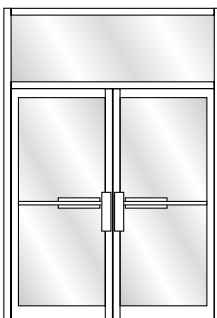

Type	Part Number	Nominal Door Size	Non-thermal Framing	Frame Size	Glazing Pocket for	(-1) Clear	(-2) Dk. Bronze	(-4) White	(-5) Black
CENTER HUNG PIVOT DOOR	CH-ETDD-1-	6'0" x 7'0"	1 ³ / ₄ " x 4 ¹ / ₂ "	75 ¹ / ₂ " x 120"	1/4"				
	CH-ETDD-2-	7'0" x 7'0"		87 ¹ / ₂ " x 120"					
	1 CH-ETDD-1-	6'0" x 7'0"	2" x 4 ¹ / ₂ "	76" x 120"	1"				
	1 CH-ETDD-2-	7'0" x 7'0"		88" x 120"					

OPTIONAL , UPON REQUEST:

- Closers - 105° H.O., 90° H.O., 90° no H.O.

COC: Units will contain doors with end-load arms and C.H. floor pivots. Frames are fabricated to receive doors and will contain concealed closers. Sash will be provided as required, in frames with transoms. **Specify Push/Pull, Push/Push or Pull/Pull.**

CXC: Units will contain doors with offset arms, slide channels and butts or offset pivots. Frames are fabricated to receive doors and will contain concealed closers, offset arm cover and door stops. Sash will be provided as required in the transom area. **Standard Push/Pull.**

CONCEALED Center Hung (COC) or Offset (CXC)

STANDARD UNIT SHIPS WITH:

- Narrow Stile Doors and 1³/₄" x 4¹/₂" Frame.
- Narrow Stile Door complete with M.S. lock, cylinders both sides, or flush bolts in the inactive leaf of a pair with push and/or pull hardware.
- Doors prepped for 1/4" glass.
- 5" Aluminum Threshold.
- 105° No H.O. Concealed Overhead Closer with Arm.

Type	Part Number	Nominal Door Size	Non-thermal Framing	Frame Size	Glazing Pocket for	(-1) Clear	(-2) Dk. Bronze	(-4) White	(-5) Black
CENTER HUNG	COC-ED-1- COC-ED-2-	3'0" x 7'0" 3'6" x 7'0"	1 ³ / ₄ " x 4 ¹ / ₂ "	39 ¹ / ₂ " x 85 ³ / ₄ " 45 ¹ / ₂ " x 85 ³ / ₄ "	1/4"				
	1 COC-ED-1- 1 COC-ED-2-	3'0" x 7'0" 3'6" x 7'0"	2" x 4 ¹ / ₂ "	40" x 86" 46" x 86"	1"				
OFFSET	CXC-ED-1- CXC-ED-2-	3'0" x 7'0" 3'6" x 7'0"	1 ³ / ₄ " x 4 ¹ / ₂ "	39 ¹ / ₂ " x 85 ³ / ₄ " 45 ¹ / ₂ " x 85 ³ / ₄ "	1/4"				
	1 CXC-ED-1- 1 CXC-ED-2-	3'0" x 7'0" 3'6" x 7'0"	2" x 4 ¹ / ₂ "	40" x 86" 46" x 86"	1"				

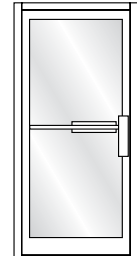

Type	Part Number	Nominal Door Size	Non-thermal Framing	Frame Size	Glazing Pocket for	(-1) Clear	(-2) Dk. Bronze	(-4) White	(-5) Black
CENTER HUNG	COC-EDD-1- COC-EDD-2-	6'0" x 7'0" 7'0" x 7'0"	1 ³ / ₄ " x 4 ¹ / ₂ "	75 ¹ / ₂ " x 85 ³ / ₄ " 87 ¹ / ₂ " x 85 ³ / ₄ "	1/4"				
	1 COC-EDD-1- 1 COC-EDD-2-	6'0" x 7'0" 7'0" x 7'0"	2" x 4 ¹ / ₂ "	76" x 86" 88" x 86"	1"				
OFFSET	CXC-EDD-1- CXC-EDD-2-	6'0" x 7'0" 7'0" x 7'0"	1 ³ / ₄ " x 4 ¹ / ₂ "	75 ¹ / ₂ " x 85 ³ / ₄ " 87 ¹ / ₂ " x 85 ³ / ₄ "	1/4"				
	1 CXC-EDD-1- 1 CXC-EDD-2-	6'0" x 7'0" 7'0" x 7'0"	2" x 4 ¹ / ₂ "	76" x 86" 88" x 86"	1"				

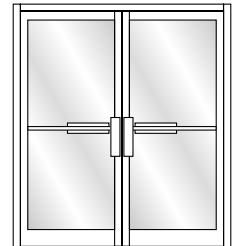

Type	Part Number	Nominal Door Size	Non-thermal Framing	Frame Size	Glazing Pocket for	(-1) Clear	(-2) Dk. Bronze	(-4) White	(-5) Black
CENTER HUNG	COC-ETD-1- COC-ETD-2-	3'0" x 7'0" 3'6" x 7'0"	1 ³ / ₄ " x 4 ¹ / ₂ "	39 ¹ / ₂ " x 120" 45 ¹ / ₂ " x 120"	1/4"				
	1 COC-ETD-1- 1 COC-ETD-2-	3'0" x 7'0" 3'6" x 7'0"	2" x 4 ¹ / ₂ "	40" x 120" 46" x 120"	1"				
OFFSET	CXC-ETD-1- CXC-ETD-2-	3'0" x 7'0" 3'6" x 7'0"	1 ³ / ₄ " x 4 ¹ / ₂ "	39 ¹ / ₂ " x 120" 45 ¹ / ₂ " x 120"	1/4"				
	1 CXC-ETD-1- 1 CXC-ETD-2-	3'0" x 7'0" 3'6" x 7'0"	2" x 4 ¹ / ₂ "	40" x 120" 46" x 120"	1"				

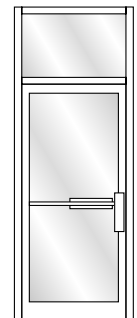

Type	Part Number	Nominal Door Size	Non-thermal Framing	Frame Size	Glazing Pocket for	(-1) Clear	(-2) Dk. Bronze	(-4) White	(-5) Black
CENTER HUNG	COC-ETDD-1- COC-ETDD-2-	6'0" x 7'0" 7'0" x 7'0"	1 ³ / ₄ " x 4 ¹ / ₂ "	75 ¹ / ₂ " x 120" 87 ¹ / ₂ " x 120"	1/4"				
	1 COC-ETDD-1- 1 COC-ETDD-2-	6'0" x 7'0" 7'0" x 7'0"	2" x 4 ¹ / ₂ "	76" x 120" 88" x 120"	1"				
OFFSET	CXC-ETDD-1- CXC-ETDD-2-	6'0" x 7'0" 7'0" x 7'0"	1 ³ / ₄ " x 4 ¹ / ₂ "	75 ¹ / ₂ " x 120" 87 ¹ / ₂ " x 120"	1/4"				
	1 CXC-ETDD-1- 1 CXC-ETDD-2-	6'0" x 7'0" 7'0" x 7'0"	2" x 4 ¹ / ₂ "	76" x 120" 88" x 120"	1"				

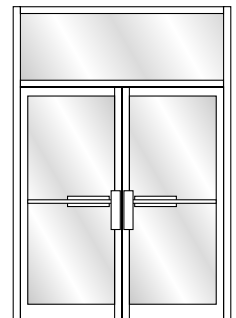

NOTE: Rebco Standard ADA Compliant Concealed Closer available

SHOWROOM ENTRANCE

(Not stocked)

STANDARD SHOWROOM UNIT INCLUDES:

Active Door

- 1 1/2 PR. Butts
- M.S. Lock with two cylinders
- Standard Push/Pull

Inactive Door

- 1 1/2 PR. Butts
- Flush Bolts
- Standard Push/Pull
- Narrow Stile Doors and 1 3/4" x 4 1/2" Framing
- Doors prepped for 1/4" glass
- 5" Aluminum Threshold
- No glass or closers are included.

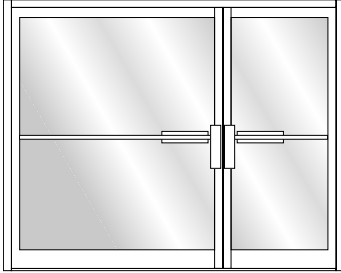

Type	Part Number	Nominal Door Size	Non-thermal Framing	Frame Size	Glazing Pocket for	(-1) Clear	(-2) Dk. Bronze	(-4) White	(-5) Black
SHOWROOM ENTRANCE	S-EDD-1-	3'0" x 7'0" & 5'0" X 7'0"	1 3/4" x 4 1/2"	99 1/2" x 85 3/4"	1/4"				
	S-EDD-2-	3'6" x 7'0" & 5'0" X 7'0"	1 3/4" x 4 1/2"	105 1/2" x 85 3/4"	1/4"				
	1 S-EDD-1-	3'0" x 7'0" & 5'0" X 7'0"	2" x 4 1/2"	100" x 86"	1"				
	1 S-EDD-2-	3'6" x 7'0" & 5'0" X 7'0"	2" x 4 1/2"	106" x 86"	1"				

© 08/2010

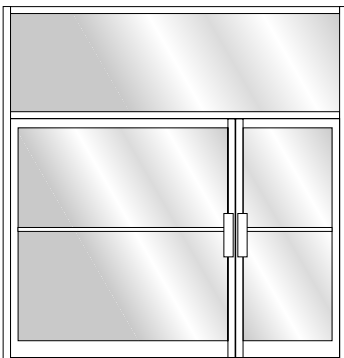

Type	Part Number	Nominal Door Size	Non-thermal Framing	Frame Size	Glazing Pocket for	(-1) Clear	(-2) Dk. Bronze	(-4) White	(-5) Black
SHOWROOM ENTRANCE	S-ETDD-1-	3'0" x 7'0" & 5'0" X 7'0"	1 3/4" x 4 1/2"	99 1/2" x 120"	1/4"				
	S-ETDD-2-	3'6" x 7'0" & 5'0" X 7'0"	1 3/4" x 4 1/2"	105 1/2" x 120"	1/4"				
	1 S-ETDD-1-	3'0" x 7'0" & 5'0" X 7'0"	2" x 4 1/2"	100" x 120"	1"				
	1 S-ETDD-2-	3'6" x 7'0" & 5'0" X 7'0"	2" x 4 1/2"	106" x 120"	1"				

BI-FOLD DOORS

Folding Doors (Narrow Stile) on Butt Hinges

STANDARD BI-FOLD UNITS INCLUDE

Active Leaf

- M.S. Lock with 2 cylinders
- Standard Push and Pull

Inactive Leaf

- Flush bolts
- Standard Push and Pull

Folding Leaves

- Surface Flush Bolts only (no Push or Pull)

Standard for all units

- Narrow Stile Door Only
- Doors to have 1-1/2 Pair Butts

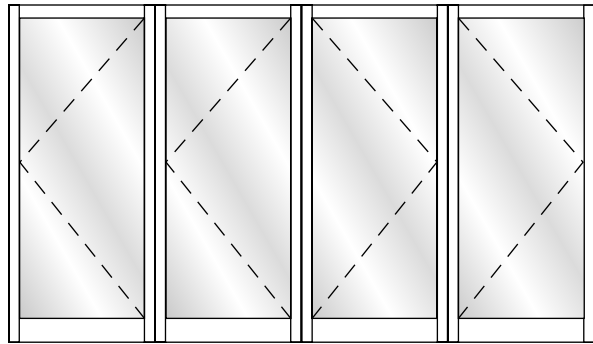

DOORS ONLY

Part Number	Nominal Door Size	(-1) Clear	(-2) Dk. Bronze	(-4) White	(-5) Black
BFD-1	3070 DOORS (OR UNDERSIZED)				
BFD-1X	OVERSIZED WIDTH OR HEIGHT	CONTACT OFFICE FOR PRICING AND AVAILABILITY			

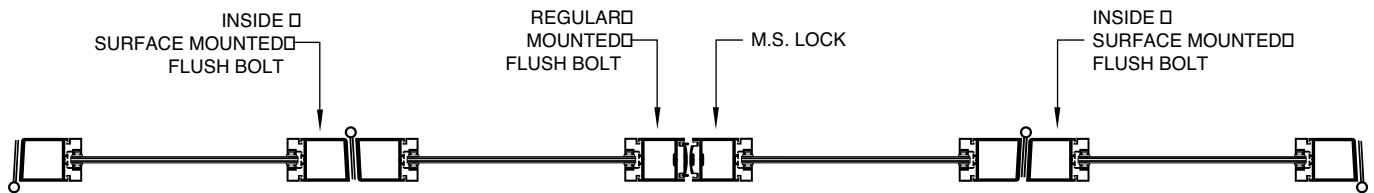

Note:

- The particular nature of Bifold Doors, most often, does not allow the doors to be of identical widths. Entrances will be calculated to provide as uniform a size as possible.
- To have doorstops in frames all doors must swing in or all doors must swing out.

REBCO BI-FOLD DOORS AND FRAMES

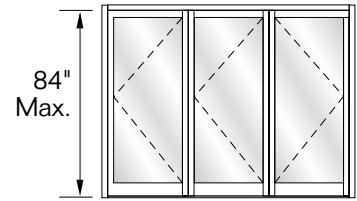

Type	Part Number	Nominal Door Size	Framing	Max. Frame Size	(-1) Clear	(-2) Dk. Bronze	(-4) White	(-5) Black
BI FOLD	BFE-A1	UP TO 3'0" x 7'0"	1 ³ / ₄ " x 4 ¹ / ₂ "	UP TO 9'3 1/2" x 7'1 ³ / ₄ "				
	BFE-A2	UP TO 3'6" x 7'0"	1 ³ / ₄ " x 4 ¹ / ₂ "	UP TO 10'9 1/2" x 7'1 ³ / ₄ "				

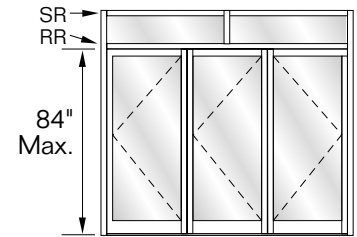

Type	Part Number	Nominal Door Size	Framing	Max. Frame Size	Transom Pocket for	(-1) Clear	(-2) Dk. Bronze	(-4) White	(-5) Black
BI FOLD	BFE-A1-T w/Transom	UP TO 3'0" x 7'0"	1 ³ / ₄ " x 4 ¹ / ₂ "	UP TO 9'3 1/2" x 10'0"	1/4" Glazing				
	BFE-A2-T w/Transom	UP TO 3'6" x 7'0"	1 ³ / ₄ " x 4 ¹ / ₂ "	UP TO 10'9 1/2" x 10'0"	1/4" Glazing				

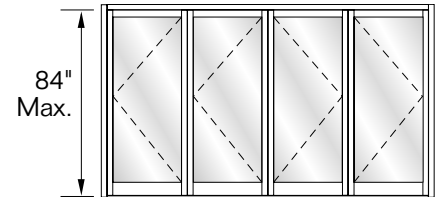

Type	Part Number	Nominal Door Size	Framing	Max. Frame Size	(-1) Clear	(-2) Dk. Bronze	(-4) White	(-5) Black
BI FOLD	BFE-B1*	UP TO 3'0" x 7'0"	1 ³ / ₄ " x 4 ¹ / ₂ "	UP TO 12'3 1/2" x 7'1 ³ / ₄ "				
	BFE-B2	UP TO 3'6" x 7'0"	1 ³ / ₄ " x 4 ¹ / ₂ "	UP TO 14'3 1/2" x 7'1 ³ / ₄ "				

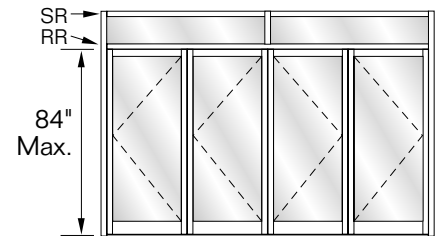

Type	Part Number	Nominal Door Size	Framing	Max. Frame Size	Transom Pocket for	(-1) Clear	(-2) Dk. Bronze	(-4) White	(-5) Black
BI FOLD	BFE-B1-T* w/Transom	UP TO 3'0" x 7'0"	1 ³ / ₄ " x 4 ¹ / ₂ "	UP TO 12'3 1/2" x 10'0"	1/4" Glazing				
	BFE-B2-T w/Transom	UP TO 3'6" x 7'0"	1 ³ / ₄ " x 4 ¹ / ₂ "	UP TO 14'3 1/2" x 10'0"	1/4" Glazing				

***Option:** shown at right are options for units BFE-B1 and BFE-B1-T. These options are for use with doors up to 3'0" only.

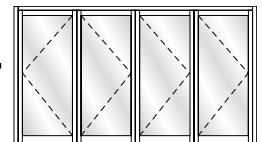

REBCO BI-FOLD DOORS AND FRAMES

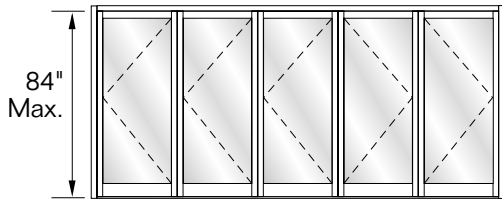

Type	Part Number	Nominal Door Size	Non-thermal Framing	Max. Frame Size	(-1) Clear	(-2) Dk. Bronze	(-4) White	(-5) Black
BI FOLD	BFE-C1	UP TO 3'0" x 7'0"	1 ³ / ₄ " x 4 ¹ / ₂ "	UP TO 15'3 ¹ / ₂ " x 7'1 ³ / ₄ "				

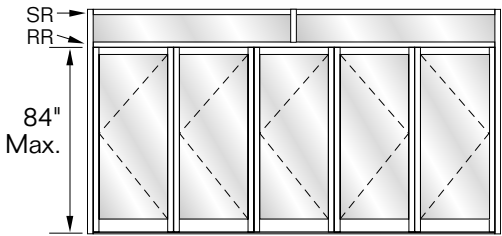

Type	Part Number	Nominal Door Size	Non-thermal Framing	Max. Frame Size	Transom Pocket for	(-1) Clear	(-2) Dk. Bronze	(-4) White	(-5) Black
BI FOLD	BFE-C1-T w/Transom	UP TO 3'0" x 7'0"	1 ³ / ₄ " x 4 ¹ / ₂ "	UP TO 15'3 ¹ / ₂ " x 10'0"	1/4" Glazing				

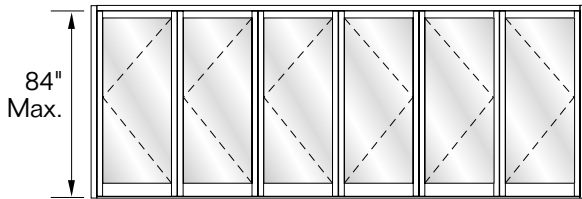

Type	Part Number	Door Size	Framing	Frame Size	(-1) Clear	(-2) Dk. Bronze	(-4) White	(-5) Black
BI FOLD	BFE-D1	UP TO 3'0" x 7'0"	1 ³ / ₄ " x 4 ¹ / ₂ "	UP TO 18'3 ¹ / ₂ " x 7'1 ³ / ₄ "				

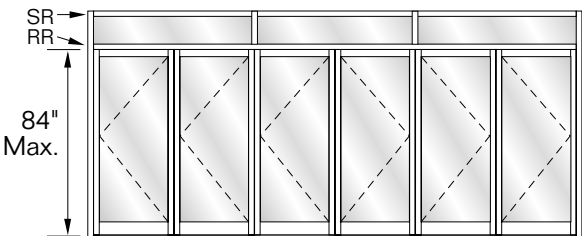

Type	Part Number	Door Size	Framing	Max. Frame Size	Transom Pocket for	(-1) Clear	(-2) Dk. Bronze	(-4) White	(-5) Black
BI FOLD	BFE-D1-T w/Transom	UP TO 3'0" x 7'0"	1 ³ / ₄ " x 4 ¹ / ₂ "	UP TO 18'3 ¹ / ₂ " x 10'0"	1/4" Glazing				

NOTE:

- **BIFOLD UNITS ARE NOT TO BE USED WITH 1" GLASS OR WITH SIDELITES.**
- **MAXIMUM OF 3 DOORS HUNG FROM ONE JAMB.**
- **NO OUTSIDE POCKETS PROVIDED.**

NARROW STILE

Entrance Doors

The best narrow stile door on the market!

With a wall thickness of .125" and stop thickness of .050", our doors are constructed with more metal than any other narrow stile door. (±.125" main members and .050 stop thickness)

Joints are mechanically fastened with the special REBCO fastener, then welded with a 100% deep penetration weld. To maintain the aesthetic beauty of our entrances, all welds are on unexposed surfaces. Complete with RebcO's standard push/pull, Adams-Rite Deadlock with cylinder both sides or flush bolts in the inactive leaf of pair. Threshold and closer not included.

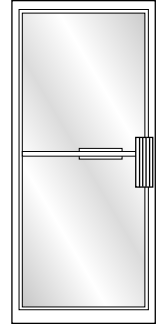

NOTE: Unless otherwise specified, doors prepped for 1/4" glass

PART #	NARROW STILE DOORS	Size	(-1) Clear	(-2) Dk.Brnz.	(-4) White	(-5) Black
NSB-1- NSB-2-	Butts (One Pair 4 1/2" x 4" B.B.)	Door 3'0" x 7'0" Door 3'6" x 7'0"				
2 NSB-1- 2 NSB-2-	Butts (One Pair 4 1/2" x 4" B.B. per door)	Pair 6'0" x 7'0" Pair 7'0" x 7'0"				
NSP-1- NSP-2-	Offset Pivots (Top and Bottom)	Door 3'0" x 7'0" Door 3'6" x 7'0"				
2 NSP-1- 2 NSP-2-	Offset Pivots (Top and Bottom) One set per door	Pair 6'0" x 7'0" Pair 7'0" x 7'0"				
NSN-1- NSN-2-	No Butts, No Pivots, No Butt or Pivot Preps	Door 3'0" x 7'0" Door 3'6" x 7'0"				
2 NSN-1- 2 NSN-2-	No Butts, No Pivots, No Butt or Pivot Preps	Pair 6'0" x 7'0" Pair 7'0" x 7'0"				
NSO-1- NSO-2-	No Butts, No Pivots, No Lock, No Push/Pull	Door 3'0" x 7'0" Door 3'6" x 7'0"				
2 NSO-1- 2 NSO-2-	No Butts, No Pivots, No Lock, No Push/Pull	Pair 6'0" x 7'0" Pair 7'0" x 7'0"				

	PART #	CUSTOM PREPS	(-1) Clear	(-2) Dk.Brnz.	(-4) White	(-5) Black
CENTER HUNG	NSC-POC- NSC-PFC-	Prep only for C.O.C. or Floor Closer Cut top and bottom inside and outside web only				
	NSC-ITA- NSC-IBA-	Install Customers Top or Bottom arm for closer Install customers top or bottom closer arm and top or bottom door portion of pivot.				
	NSC-RAP-	Install REBCO's standard top arm and bottom door portion of pivot only				
OFFSET	NSO-POC- NSO-PFC-	Prep only for C.O.C. or Floor Closer Cut top and/or bottom inside web as required and notch face of door for arm.				
	NSO-ITA- NSO-IBA-	Install Customers top or bottom closer arm only Cut top and/or bottom inside web as required and notch face of door. Install closer arm.				
	NSC-ROP-	Install REBCO's offset top arm & slide channel in door				

D. O.	Actual Size	Part #	Clear Glass	Note: Glass width for C.H. Double Acting Doors, deduct 3/16" from glass sizes shown at left
2'6" x 7'0"	29 7/8" x 83 1/4"	N/A	N/A	
3'0" x 7'0"	35 7/8" x 83 1/4"	GLI (installed)		
3'0" x 7'0"	35 7/8" x 83 1/4"	GLI-L (loose)		
3'6" x 7'0"	41 7/8" x 83 1/4"	N/A	N/A	

Part	Finish	Part #	Door Only	Part #	Door & Frame
Extra Butt	Clear	3BD-1		3BF-1	
	Bronze	3BD-2		3BF-2	
Intermediate Pivot	Clear	IPD-1		IPF-1	
	Bronze	IPD-2		IPF-2	

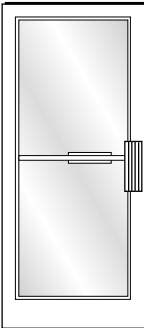

With a wall thickness of .125" and stop thickness of .050", our doors are constructed for superior durability. For strength, joints are mechanically fastened, interlocked, bolted and then welded with a 100% deep penetration weld. To maintain the aesthetic beauty of our entrances, all welds are on unexposed surfaces.

REBCO strongly recommends 3 butts or adding an intermediate pivot on medium stile doors.

3 1/2" MEDIUM STILE Entrance Doors

UNIT INCLUDES:

- Includes Pivots and Butts
- Threshold & Closer not included
- Deadlock with cylinder both sides or flush bolts in the inactive leaf of pair.
- Standard Push/Pull hardware

PART #	MEDIUM STILE DOORS	Size	(-1) Clear	(-2) Dk.Brnz.	(-4) White	(-5) Black
MSB-1-MSB-2-	Butts (One Pair 4 1/2" x 4" B.B.)	Door 3'0" x 7'0" Door 3'6" x 7'0"				
2 MSB-1-2 MSB-2-	Butts (One Pair 4 1/2" x 4" B.B. per door)	Pair 6'0" x 7'0" Pair 7'0" x 7'0"				
MSP-1-MSP-2-	Offset Pivots (Top and Bottom)	Door 3'0" x 7'0" Door 3'6" x 7'0"				
2 MSP-1-2 MSP-2-	Offset Pivots (Top and Bottom) One set per door	Pair 6'0" x 7'0" Pair 7'0" x 7'0"				
MSN-1-MSN-2-	No Butts, No Pivots, No Butt or Pivot Preps	Door 3'0" x 7'0" Door 3'6" x 7'0"				
2 MSN-1-2 MSN-2-	No Butts, No Pivots, No Butt or Pivot Preps	Pair 6'0" x 7'0" Pair 7'0" x 7'0"				
MSO-1-MSO-2-	No Butts, No Pivots, No Lock, No Push/Pull	Door 3'0" x 7'0" Door 3'6" x 7'0"				
2 MSO-1-2 MSO-2-	No Butts, No Pivots, No Lock, No Push/Pull	Pair 6'0" x 7'0" Pair 7'0" x 7'0"				
Add for Custom Size Up to 48" x 96"						
Add for Custom Size Under 36" x 84"						

	PART #	CUSTOM PREPS	(-1) Clear	(-2) Dk.Brnz.	(-4) White	(-5) Black
CENTER HUNG	MSC-POC-MSB-PFC-	Prep only for C.O.C. or Floor Closer Cut top and bottom inside and outside web only	Includes Center Hung Door			
	MSC-ITA-MSB-IBA-	Install Customers Top or Bottom arm for closer Install customers top or bottom closer arm and top or bottom door portion of pivot.				
	MSC-RAP-	Install REBCO's standard top arm and bottom door portion of pivot only				
OFFSET	MSO-POC-MSO-PFC-	Prep only for C.O.C. or Floor Closer Cut top and/or bottom inside web as required and notch face of door for arm.	Add to butt or pivot door.			
	MSO-ITA-MSO-IBA-	Install Customers top or bottom closer arm only Cut top and/or bottom inside web as required and notch face of door. Install closer arm.				
	MSC-ROP-	Install REBCO's offset top arm & slide channel in door				

D. O.	Actual Size	Part #	Clear Glass	Note: Glass width for C.H. Double Acting Doors, deduct 3/16" from glass sizes shown at left
2'6" x 7'0"	29 7/8" x 83 1/4"	N/A	N/A	
3'0" x 7'0"	35 7/8" x 83 1/4"	N/A	N/A	
3'6" x 7'0"	41 7/8" x 83 1/4"	N/A	N/A	

Part	Finish	Part #	Door Only	Part #	Door & Frame
Extra Butt	Clear	3BD-1		3BF-1	
	Bronze	3BD-2		3BF-2	
Intermediate Pivot	Clear	IPD-1		IPF-1	
	Bronze	IPD-2		IPF-2	



5" WIDE STILE

Entrance Doors

With a wall thickness of .125" and stop thickness of .050", our doors are constructed for superior durability. For strength, joints are mechanically fastened, interlocked, bolted and then welded with a 100% deep penetration weld. To maintain the aesthetic beauty of our entrances, all welds are on unexposed surfaces.

UNIT INCLUDES:

- Deadlock with cylinder both sides or flush bolts in the inactive leaf of pair.
- Standard Push/Pull hardware
- Includes Pivots and Butts
- Threshold & Closer not included

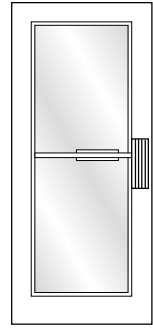

REBCO strongly recommends 3 butts or adding an intermediate pivot on wide stile doors.

PART #	WIDE STILE DOORS	Size	(-1) Clear	(-2) Dk.Brnz.	(-4) White	(-5) Black
WSB-1- WSB-2-	Butts (One Pair 4 1/2" x 4" B.B.)	Door 3'0" x 7'0" Door 3'6" x 7'0"				
2 WSB-1- 2 WSB-2-	Butts (One Pair 4 1/2" x 4" B.B. per door)	Pair 6'0" x 7'0" Pair 7'0" x 7'0"				
WSP-1- WSP-2-	Offset Pivots (Top and Bottom)	Door 3'0" x 7'0" Door 3'6" x 7'0"				
2 WSP-1- 2 WSP-2-	Offset Pivots (Top and Bottom) One set per door	Pair 6'0" x 7'0" Pair 7'0" x 7'0"				
WSN-1- WSN-2-	No Butts, No Pivots, No Butt or Pivot Preps	Door 3'0" x 7'0" Door 3'6" x 7'0"				
2 WSN-1- 2 WSN-2-	No Butts, No Pivots, No Butt or Pivot Preps	Pair 6'0" x 7'0" Pair 7'0" x 7'0"				
WSO-1- WSO-2-	No Butts, No Pivots, No Lock, No Push/Pull	Door 3'0" x 7'0" Door 3'6" x 7'0"				
2 WSO-1- 2 WSO-2-	No Butts, No Pivots, No Lock, No Push/Pull	Pair 6'0" x 7'0" Pair 7'0" x 7'0"				
Add for Custom Size Up to 48" x 96"						
Add for Custom Size Under 36" x 84"						

	PART #	CUSTOM PREPS	(-1) Clear	(-2) Dk.Brnz.	(-4) White	(-5) Black
CENTER HUNG	WSC-POC- WSC-PFC-	Prep only for C.O.C. or Floor Closer Cut top and bottom inside and outside web only				
	WSC-ITA- WSC-IBA-	Install Customers Top or Bottom arm for closer Install customers top or bottom closer arm and top or bottom door portion of pivot.				
	WSC-RAP-	Install REBCO's standard top arm and bottom door portion of pivot only				
OFFSET	WSO-POC- WSO-PFC-	Prep only for C.O.C. or Floor Closer Cut top and/or bottom inside web as required and notch face of door for arm.				
	WSO-ITA- WSO-IBA-	Install Customers top or bottom closer arm only Cut top and/or bottom inside web as required and notch face of door. Install closer arm.				
	WSC-ROP-	Install REBCO's offset top arm & slide channel in door				

D. O.	Actual Size	Part #	Clear Glass	Note: Glass width for C.H. Double Acting Doors, deduct 3/16" from glass sizes shown at left
2'6" x 7'0"	29 7/8" x 83 1/4"	N/A	N/A	
3'0" x 7'0"	35 7/8" x 83 1/4"	N/A	N/A	
3'6" x 7'0"	41 7/8" x 83 1/4"	N/A	N/A	

Part	Finish	Part #	Door Only	Part #	Door & Frame
Extra Butt	Clear	3BD-1		3BF-1	
	Bronze	3BD-2		3BF-2	
Intermediate Pivot	Clear	IPD-1		IPF-1	
	Bronze	IPD-2		IPF-2	

UNIT INCLUDES:

- M.S. lock with 2 cylinders or flush bolts in inactive leaf of pair.
- Standard Push/Pull hardware.
- Standard frames are 1³/₄" x 4¹/₂" with 5" threshold.
- Doors require 1¹/₂ pair butts or top, bottom & int. pivots.
- No center hung, C.O.C., or floor closer application possible.
- Concealed rod panics cannot be applied to full flush door.
- Rim panics or surface mounted vertical rod panic only.

FLUSH DOORS

Flush doors have welded frame construction with aluminum sheet laminations to 3/8" hardboard and honeycomb core. Vertical and horizontal reinforcing rails are installed inside the door skeleton for strength.

Flush doors are available with vision panels in standard or custom designs

Face sheets are .040 smooth aluminum.

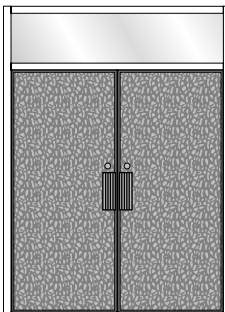
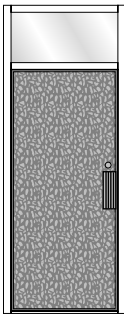
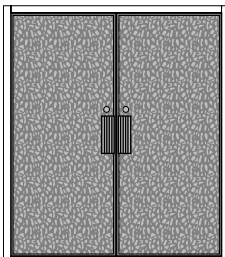
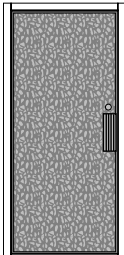

Type	Part Number	DOOR ONLY Size		(-1) Clear	(-2) Dk. Bronze	(-4) White	(-5) Black
BUTT HUNG	FLB-1-	3'0" x 7'0"	X				
	FLB-2-	3'6" x 7'0"					
OFFSET PIVOT	FLP-1-	3'0" x 7'0"					
	FLP-2-	3'6" x 7'0"					

Type	Part Number	Nominal Door Size	Non-thermal Framing	Frame Size	Glazing Pocket for	(-1) Clear	(-2) Dk. Bronze	(-4) White	(-5) Black
BUTT HUNG	FLB-ED-1-	3'0" x 7'0"	1 ³ / ₄ " x 4 ¹ / ₂ "	39 ¹ / ₂ " x 85 ³ / ₄ "	1/4"				
	FLB-ED-2-	3'6" x 7'0"							
	1 FLB-ED-1-	3'0" x 7'0"	2" x 4 ¹ / ₂ "	40" x 86"	1"				
	1 FLB-ED-2-	3'6" x 7'0"							
OFFSET PIVOT	FLP-ED-1-	3'0" x 7'0"	1 ³ / ₄ " x 4 ¹ / ₂ "	39 ¹ / ₂ " x 85 ³ / ₄ "	1/4"				
	FLP-ED-2-	3'6" x 7'0"							
	1 FLP-ED-1-	3'0" x 7'0"	2" x 4 ¹ / ₂ "	40" x 86"	1"				
	1 FLP-ED-2-	3'6" x 7'0"							

Type	Part Number	Nominal Door Size	Non-thermal Framing	Frame Size	Glazing Pocket for	(-1) Clear	(-2) Dk. Bronze	(-4) White	(-5) Black
BUTT HUNG	FLB-EDD-1-	6'0" x 7'0"	1 ³ / ₄ " x 4 ¹ / ₂ "	75 ¹ / ₂ " x 85 ³ / ₄ "	1/4"				
	FLB-EDD-2-	7'0" x 7'0"							
	1 FLB-EDD-1-	6'0" x 7'0"	2" x 4 ¹ / ₂ "	76" x 86"	1"				
	1 FLB-EDD-2-	7'0" x 7'0"							
OFFSET PIVOT	FLP-EDD-1-	6'0" x 7'0"	1 ³ / ₄ " x 4 ¹ / ₂ "	75 ¹ / ₂ " x 85 ³ / ₄ "	1/4"				
	FLP-EDD-2-	7'0" x 7'0"							
	1 FLP-EDD-1-	6'0" x 7'0"	2" x 4 ¹ / ₂ "	76" x 86"	1"				
	1 FLP-EDD-2-	7'0" x 7'0"							

Type	Part Number	Nominal Door Size	Non-thermal Framing	Frame Size	Glazing Pocket for	(-1) Clear	(-2) Dk. Bronze	(-4) White	(-5) Black
BUTT HUNG	FLB-ETD-1-	3'0" x 7'0"	1 ³ / ₄ " x 4 ¹ / ₂ "	39 ¹ / ₂ " x 120"	1/4"				
	FLB-ETD-2-	3'6" x 7'0"							
	1 FLB-ETD-1-	3'0" x 7'0"	2" x 4 ¹ / ₂ "	40" x 120"	1"				
	1 FLB-ETD-2-	3'6" x 7'0"							
OFFSET PIVOT	FLP-ETD-1-	3'0" x 7'0"	1 ³ / ₄ " x 4 ¹ / ₂ "	39 ¹ / ₂ " x 120"	1/4"				
	FLP-ETD-2-	3'6" x 7'0"							
	1 FLP-ETD-1-	3'0" x 7'0"	2" x 4 ¹ / ₂ "	40" x 120"	1"				
	1 FLP-ETD-2-	3'6" x 7'0"							

Type	Part Number	Nominal Door Size	Non-thermal Framing	Frame Size	Glazing Pocket for	(-1) Clear	(-2) Dk. Bronze	(-4) White	(-5) Black
BUTT HUNG	FLB-ETDD-1-	6'0" x 7'0"	1 ³ / ₄ " x 4 ¹ / ₂ "	75 ¹ / ₂ " x 120"	1/4"				
	FLB-ETDD-2-	7'0" x 7'0"							
	1 FLB-ETDD-1-	6'0" x 7'0"	2" x 4 ¹ / ₂ "	76" x 120"	1"				
	1 FLB-ETDD-2-	7'0" x 7'0"							
OFFSET PIVOT	FLP-ETDD-1-	6'0" x 7'0"	1 ³ / ₄ " x 4 ¹ / ₂ "	75 ¹ / ₂ " x 120"	1/4"				
	FLP-ETDD-2-	7'0" x 7'0"							
	1 FLP-ETDD-1-	6'0" x 7'0"	2" x 4 ¹ / ₂ "	76" x 120"	1"				
	1 FLP-ETDD-2-	7'0" x 7'0"							

Custom Sizing	Size	(-1) Clear	(-2) Dk. Brz.	(-4) White	(-5) Black
ADD for special size	From 42" x 84" to 48" x 96"				

FRP DOORS

UNIT INCLUDES:

- Continuous Hinges.
- Bronze and clear finishes standard. Other colors available.
- High Density Polystyrene Core.
- Four member, heavy walled subframe with mortise and tenon joints.
- Fiberglass reinforced polyester panels are .120" thick.
- Color is solid throughout panels, making it scratch resistant.

- Aluminum Trim Caps.
- Single Pile weather-stripping for pairs of doors.
- Basic package consists of blank door panels. Push/pulls & locks are not included. See page 15 for hardware details.
- Top & Bottom Rails are 1 1/2" x 6"
- Side Rails are 1 1/2" x 5 3/4"
- Face sheets have a pebble-like embossed finish.

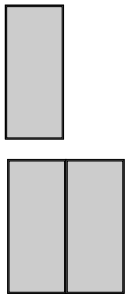

Part Number	DOOR ONLY Nominal Size Door up to:
FRP-37	3'0" x 7'0"
FRP-38	3'0" x 8'0"
FRP-47	4'0" x 7'0"
FRP-48	4'0" x 8'0"
FRP-67	6'0" x 7'0"
FRP-68	6'0" x 8'0"
FRP-87	8'0" x 7'0"
FRP-88	8'0" x 8'0"

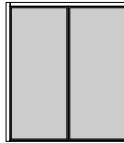

Part Number	Nom. Door Size, up to:	Non-thermal Framing	Frame Size	Glazing Pocket for
FRP-ED-37	3'0" x 7'0"	1 3/4" x 4 1/2"	39 1/2" x 85 3/4"	1/4"
1 FRP-ED-37	3'0" x 7'0"	2" x 4 1/2"	40" x 86"	1"
FRP-ED-38	3'0" x 8'0"	1 3/4" x 4 1/2"	39 1/2" x 97 3/4"	1/4"
1 FRP-ED-38	3'0" x 8'0"	2" x 4 1/2"	40" x 98"	1"
FRP-ED-47	4'0" x 7'0"	1 3/4" x 4 1/2"	51 1/2" x 85 3/4"	1/4"
1 FRP-ED-47	4'0" x 7'0"	2" x 4 1/2"	52" x 86"	1"
FRP-ED-48	4'0" x 8'0"	1 3/4" x 4 1/2"	51 1/2" x 97 3/4"	1/4"
1 FRP-ED-48	4'0" x 8'0"	2" x 4 1/2"	52" x 98"	1"
FRP-EDD-37	3'0" x 7'0"	1 3/4" x 4 1/2"	75 1/2" x 85 3/4"	1/4"
1 FRP-EDD-37	3'0" x 7'0"	2" x 4 1/2"	76" x 86"	1"
FRP-EDD-38	3'0" x 8'0"	1 3/4" x 4 1/2"	75 1/2" x 97 3/4"	1/4"
1 FRP-EDD-38	3'0" x 8'0"	2" x 4 1/2"	76" x 98"	1"
FRP-EDD-47	4'0" x 7'0"	1 3/4" x 4 1/2"	99 1/2" x 85 3/4"	1/4"
1 FRP-EDD-47	4'0" x 7'0"	2" x 4 1/2"	100" x 86"	1"
FRP-EDD-48	4'0" x 8'0"	1 3/4" x 4 1/2"	99 1/2" x 97 3/4"	1/4"
1 FRP-EDD-48	4'0" x 8'0"	2" x 4 1/2"	100" x 98"	1"



Call for pricing.

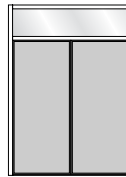

Part Number	Nom. Door Size, up to:	Non-thermal Framing	Frame Size	Glazing Pocket for
FRP-ETD-37	3'0" x 7'0"	1 3/4" x 4 1/2"	39 1/2" x 120"	1/4"
1 FRP-ETD-37	3'0" x 7'0"	2" x 4 1/2"	40" x 120"	1"
FRP-ETD-38	3'0" x 8'0"	1 3/4" x 4 1/2"	39 1/2" x 120"	1/4"
1 FRP-ETD-38	3'0" x 8'0"	2" x 4 1/2"	40" x 120"	1"
FRP-ETD-47	4'0" x 7'0"	1 3/4" x 4 1/2"	51 1/2" x 120"	1/4"
1 FRP-ETD-47	4'0" x 7'0"	2" x 4 1/2"	52" x 120"	1"
FRP-ETD-48	4'0" x 8'0"	1 3/4" x 4 1/2"	51 1/2" x 120"	1/4"
1 FRP-ETD-48	4'0" x 8'0"	2" x 4 1/2"	52" x 120"	1"

Part Number	Nom. Door Size, up to:	Non-thermal Framing	Frame Size	Glazing Pocket for
FRP-ETDD-67	6'0" x 7'0"	1 3/4" x 4 1/2"	75 1/2" x 120"	1/4"
1 FRP-ETDD-67	6'0" x 7'0"	2" x 4 1/2"	76" x 120"	1"
FRP-ETDD-68	6'0" x 8'0"	1 3/4" x 4 1/2"	75 1/2" x 120"	1/4"
1 FRP-ETDD-68	6'0" x 8'0"	2" x 4 1/2"	76" x 120"	1"
FRP-ETDD-87	8'0" x 7'0"	1 3/4" x 4 1/2"	99 1/2" x 120"	1/4"
1 FRP-ETDD-87	8'0" x 7'0"	2" x 4 1/2"	100" x 120"	1"
FRP-ETDD-88	8'0" x 8'0"	1 3/4" x 4 1/2"	99 1/2" x 120"	1/4"
1 FRP-ETDD-88	8'0" x 8'0"	2" x 4 1/2"	100" x 120"	1"

OPTIONS & ACCESSORIES

	(-1) Clear /Gray	(-2) Bronze /Brown	Other Finishes
Half Lite Top half of door only			
10" x 10" or 12" x 12" Vision Lite Top of door only			

	(-1) Clear /Gray	(-2) Bronze /Brown	Other Finishes
5" x 30" Narrow Lite at top of door only			
Recessed Pull			
Additional Panels: for transom & sidelights, loose panels are available.			

CUSTOM HARDWARE -

PUSH/PULLS Add on for REBCO standard Push & Pulls. See pg. 22. Recessed pulls, see above.

LOCKS MS or Latch Locks as required. See page 24 & 25.

PANIC DEVICES Door-o-matic Rim, A/R Mortised (8400) or A/R Surface Mounted Rods (8200) Panic. See page 20.

OTHER CUSTOM HARDWARE APPLICATION Call our Door Department.

DOOR GRIDS

CALL FOR PRICING

GRID CONSTRUCTION

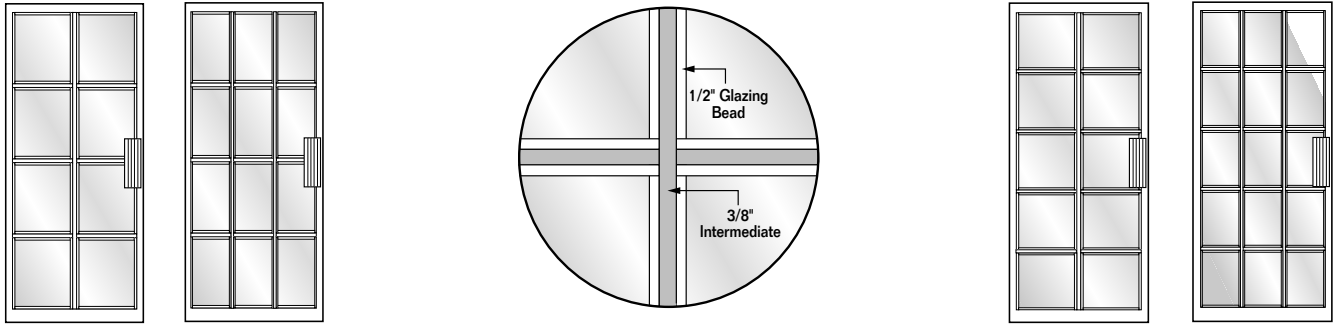

Various Grid Configurations Available Upon Request.

**Door Grids: Installed in Doors:
Installed in Frames:**

The basic door is medium stile with a cross buck panel on the bottom. This panel is a full 1 1/2" thick for strength and insulation. (Also available is a smooth or stucco finished 1 1/2" panel in lieu of cross buck panel.) The Colonial door features an authentic six or nine lite colonial look with a 3" intermediate rail (excluding glass bead).

Custom sizes are also available. For custom sizes, see Medium Stile Doors on page 11.

Stiles: 3 1/2" • Bottom Rail: 6 13/16" • Top Rail: 3 7/16"
Vertical and Horizontal glass dividers 3/8" (excluding glass bead).

COLONIAL DOORS

With 6 or 9 Lites

STANDARD COLONIAL DOOR INCLUDES:

- Maximum security lock with cylinder both sides.
- 1 1/2 pair butts or top, bottom and intermediate pivot.
- Standard push/pull.

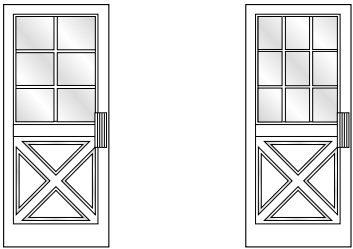

STANDARD PUSH/PULL

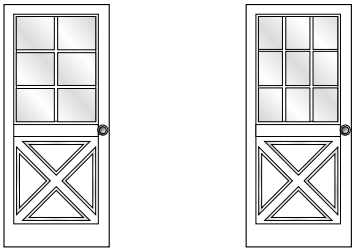

KNOB LOCK

DOORS ONLY

Type	Nominal Door Size	6 Lite Door Part Number	6 Lite (-4) White Only	9 Lite Door Part Number	9 Lite (-4) White Only
BUTT HUNG	3'0" x 7'0"	CL-BD6-1		CL-BD9-1	
	3'6" x 7'0"	CL-BD6-2		CL-BD9-2	
OFFSET PIVOT	3'0" x 7'0"	CL-PD6-1		CL-PD9-1	
	3'6" x 7'0"	CL-PD6-2		CL-PD9-2	

KNOB LOCK OPTION	
Knob lock set	See pg. 26
Dummy Knob lock	See pg. 26

CUSTOM PANEL DOORS



DOOR	PANEL	PART #	(-1) CLEAR	(-2) DK.BRNZ.	(-4) WHITE	(-5) BLACK
1/4" Full Panel with Required 2" Intermediate Rail	Anodized 1/4" Panel	QFPA-				
	Painted 1/4" Panel					
Full Panel	Painted * 1"	OFPP-	(-9) Paint	(-3) Paint		
	Painted Rebco 1 1/2"					
Horizontal Half Panel 41-5/8" to centerline of mid-rail from bottom of door (2" intermediate rail.)	1/4" Anod.	QHHA-				
	1/4" Paint	QHHP-				
	* 1" Paint	OHHP-				
	1 1/2" Anod.	RHHP-				
Vertical Half Panel Includes 41030 Muntin	1/4" Anod.	QVHA-				
	1/4" Paint	QVHP-				
	*1" Paint	OVHP-				
	1 1/2" Paint	RVHP-				
Sign Panel (10-3/4") 45-3/8" from top of sign panel to bottom of door	1/4" Anod.	QSPA-				
	1/4" Paint	QSPP-				
	*1" Paint	OSPP-				
	1 1/2" Paint	RSPA-				
12" x 12" or 24" x 24" Vision Panel	1/4" Anod.					
	*1" Paint					
	1 1/2" Paint	SVP-				
6" x 36" Vision Panel	1/4" Anod.					
	*1" Paint					
	1 1/2" Paint	RVP-				
Any Other Size of Vision Panel	1/4" Anod.					
	*1" Paint					
	1 1/2" Paint	CVP-				

NOTE: Standard anodized panels and standard painted panels are Stucco finish. Smooth anodized panels available at no extra charge but must be requested.

*1" Panel is available in painted finishes only (not anodized).

CUSTOM RAILS & KICKPLATES

INTERMEDIATE HORIZONTAL RAIL

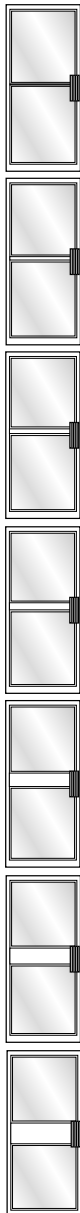

3/8" (H41-020) Intermediate Rail (Size does not include Glass Beads)	(-1) Clear (-2) Dk.Brz. (-4) White (-5) Black	
2" (H41-030) Intermediate Rail (Size does not include Glass Beads)	(-1) Clear (-2) Dk.Brz. (-4) White (-5) Black	
3" (H41-035) Intermediate Rail (Size does not include Glass Beads)	(-1) Clear (-2) Dk.Brz. (-4) White (-5) Black	
4-1/2" (H41-045) Intermediate Rail (Size does not include Glass Beads)	(-1) Clear (-2) Dk.Brz. (-4) White (-5) Black	
5-3/4" (H41-057) Intermediate Rail (Size does not include Glass Beads)	(-1) Clear (-2) Dk.Brz. (-4) White (-5) Black	
7-9/16" (H41-067) Intermediate Rail (Size does not include Glass Beads)	(-1) Clear (-2) Dk.Brz. (-4) White (-5) Black	
10" (H41-010) Intermediate Rail (Size does not include Glass Beads)	(-1) Clear (-2) Dk.Brz. (-4) White (-5) Black	

DECO-MIDPANEL

Complete with M.S. Lock, 2 cylinders and tapered push/pull. Panel area supplied open with glazing beads to insert 1/4" panel or glass. (White door gets clear accessories).

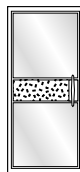

Deco-Midpanel add on for doors up to 42" wide (D-MP)	(-1) Clear (-2) Dk.Brz. (-4) White (-5) Black	
For special size over 42" x 84" up to 48" x 96" (D-MPX)	(-1) Clear (-2) Dk.Brz. (-4) White (-5) Black	

KICKPLATE (Applied to both sides of door)



		.080	.125
(KP12-) up to 12" high 1/8" Aluminum Kickplate	(-1) Clear (-2) Dk.Brz. (-4) White (-5) Black		
(KP18-) up to 18" high 1/8" Aluminum Kickplate	(-1) Clear (-2) Dk.Brz. (-4) White (-5) Black		
(KP24-) up to 24" high 1/8" Aluminum Kickplate	(-1) Clear (-2) Dk.Brz. (-4) White (-5) Black		
(KP36-) up to 36" high 1/8" Aluminum Kickplate	(-1) Clear (-2) Dk.Brz. (-4) White (-5) Black		

VERTICAL RAILS

Glass and/or Panels not included. Unless a custom vertical rail location is requested, vertical rails will be mounted 1/3rd of the door width from the lock stile.



3/8" (V41-020) Vertical Rail	(-1) Clear (-2) Dk.Brz. (-4) White (-5) Black	
2" (V41-030) Vertical Rail	(-1) Clear (-2) Dk.Brz. (-4) White (-5) Black	
3" (V41-035) Vertical Rail	(-1) Clear (-2) Dk.Brz. (-4) White (-5) Black	
4-1/2" (V41-045) Vertical Rail	(-1) Clear (-2) Dk.Brz. (-4) White (-5) Black	

DOOR GLAZING BEADS

Standard Doors will be prepped for 1/4" glazing unless otherwise specified.

Options at no charge: Door can be prepped for 5/8" or 1" glazing upon request only.

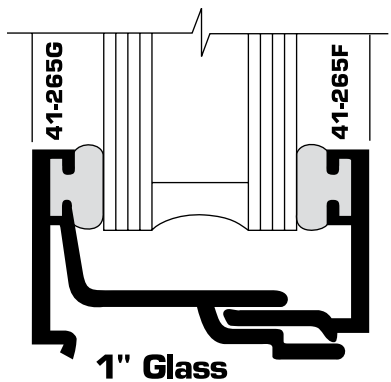
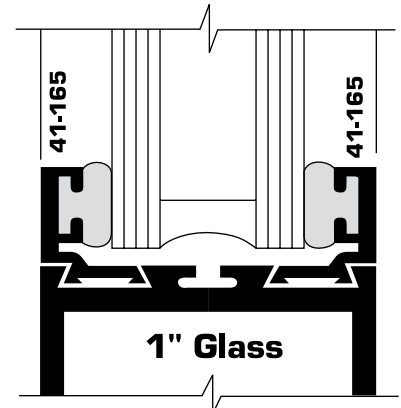
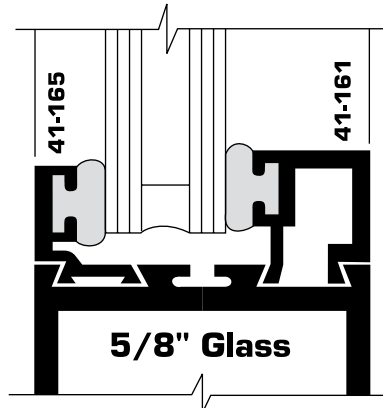
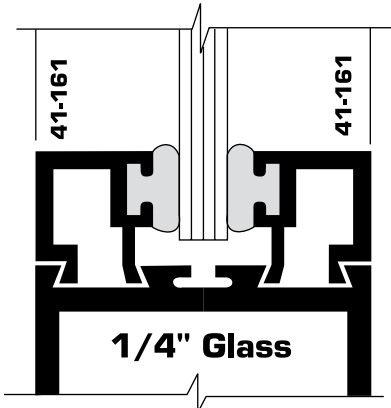

Special 1" Glazing - #41-265I

2 piece glazing member providing extra height for coverage of most spacers used in 1" thermal glass units.

ADD TO BASIC DOOR PRICE (Price includes installation)					
Part #	Components	Clear (-1)	Bronze (-2)	White (-4)	Black (-5)
41-6161	41-161/41-161				
41-6165	41-165/41-161				
41-6565	41-165/41-165				
41-265I	41-265F/41-265G				

PREPARED ALUMINUM THRESHOLDS

ITEM	BUTTS		OFFSET PIVOTS PREP ONLY		*FOR C.H. PIVOT PREP ONLY	
	SINGLE to 42"	PAIR to 84"	SINGLE to 42"	PAIR to 84"	SINGLE to 42"	PAIR to 84"
4" Threshold #62-040	#62-041	#62-042	#62-043	#62-044	#62-045	#62-046
5" Threshold #62-050	#62-051	#62-052	#62-053	#62-054	#62-055	#62-056
5" Panic Threshold #62-057 P-0	#62-057PB-0	#62-059PB-0	#62-057PP-0	#62-059PP-0		
4 1/2" Panic Threshold #62-058W (1/2" Overall Height)	#62-058B	#62-059B				
6" Threshold #62-060	#62-061	#62-062	#62-063	#62-064	#62-065	#62-066
7" Threshold #62-070	#62-071	#62-072	#62-073	#62-074	#62-075	#62-076
10" Threshold #62-010	#62-011	#62-012	#62-013	#62-014	#62-015	#62-016

* If pivots other than REBCO standards are being used, floor portion of pivot must be provided. 62-058 W cannot be used with Pivots.

Special Thresholds are available upon request to meet your specifications.

HEADERS & CLOSERS (Concealed and Surface Mounted)

PART #	HEADERS ONLY – Prepared for C.O.C. Closers Add closer. Add channel cover door stop if offset.	(-1) CLEAR	(-2) DK. BRONZE	(-4) WHITE	(-5) BLACK
64-45H1-	4517 OH & OHF	Single Door to 42"			
64-45H2-	w/cover plate	Pair to 84"			
64-42H1-	4017, 4517 or 4520 System	Single Door to 42"			
64-42H2-	w/cover plate	Pair to 84"			
64-68H1-	6017, 6020 or 8020 System	Single Door to 42"			
64-68H2-	w/cover plate	Pair to 84"			

LOOSE - C. O. C. OPTIONS	PART #	CENTERHUNG				OFFSET			
		(-1) CLEAR	(-2) DK. BRZ.	(-4) WHITE	(-5) BLACK	(-1) CLEAR	(-2) DK. BRZ.	(-4) WHITE	(-5) BLACK
Concealed Overhead Closer Set: (Closer, End Load Arm & Brackets) Specify Hold Open, No Hold Open & Degree of Opening (90° or 105°)	64-CCA								
	64-XCA					(Includes Offset Arm & Slide Channel)			
A.D.A. Compliant C.O.C. Set: (A.D.A Compliant Closer End Load Arm & Brackets) 105° Hold Open Stocked	64-CCADA								
	64-XCADA					(Includes Offset Arm & Slide Channel)			
End Load Arm Only	64-ARM								
Offset Arm Only	64-XAC					N/A	N/A	N/A	N/A
Offset Arm & Slide Channel-Sets only	64-ASC								
Cover Plate Only - International	64-CPO								
Channel Door Stop (for offset arm up to 42")	64-XDS								

INSTALLED - C.O.C. OPTIONS Includes closer mounted in header. If not specified, 105° hold open closer will be provided.	PART # CENTER HUNG	CENTERHUNG				PART # OFFSET	OFFSET (Includes loose channel door stop)			
		(-1) CLEAR	(-2) DK. BRZ.	(-4) WHITE	(-5) BLACK		(-1) CLEAR	(-2) DK. BRZ.	(-4) WHITE	(-5) BLACK
In 4517 OH Header	Single Door to 42"	64-5CH1I-				64-5XH1I-				
	Pair to 84"	64-5CH2I-				64-5XH2I-				
In 4017, 4517 or 4520 System	Single Door to 42"	64-2CH1I-				64-2XH1I-				
	Pair to 84"	64-2CH2I-				64-2XH2I-				
In 6020 or 8020 Systems	Single Door to 42"	64-8CH1I-				64-8XH1I-				
	Pair to 84"	64-8CH2I-				64-8XH2I-				
Other										

PART#	SURFACE CLOSERS	(-1) CLEAR	(-2) DK. BRONZE	(-4) WHITE	(-5) BLACK	W/H.O. STD.	W/H.O. BRONZE
64-CL1-	International Closer #784 each						
64-CLG-	International Closer, Case of 6						
64-CLADA-	ADA Compliant International Closer (#8052)						
64-PAK-	Parallel Arm Kit - (with bracket)						
64-BC1-	4 - B.C.						
64-DPL-	Drop Plate						
	Special: LCN, Norton, Rixson Etc.	Price and Availability upon Request					



SURFACE VERTICAL ROD PANIC

PART NO.	INSTALLED HARDWARE	(-1) Clear	(-2) Dk.Brnz.
64-SVRP-	Adams Rite #8200, 7' 0", Surface Mounted Vertical Rod Panic w/Offset Wire Pull & Cylinder		

RIM PANIC

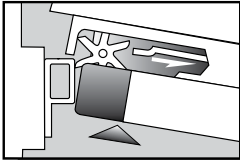

#8800

PART NO.	INSTALLED HARDWARE	(-1) Clear	(-2) Dk.Brnz.
64-ARRP-	Adams Rite #8800 7' 0", with Offset Wire Pull & Cylinder		

MORTISED PANIC

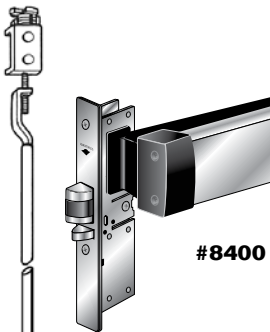

#8400

PART NO.	INSTALLED HARDWARE	(-1) Clear	(-2) Dk.Brnz.
64-AMP-	Adams Rite #8400 Panic (MORTISED) with Offset Wire Pulls & Cylinder		
64-ADP-	Adams Rite #8099 Dummy Panic with Pull Provided.		

CONCEALED ROD PANIC



#8600

PART NO.	INSTALLED HARDWARE	(-1) Clear	(-2) Dk.Brnz.
64-ARCP-	Adams Rite #8600 7' 0", with Offset Wire Pull & Cylinder		

IN-LINE PANICS

INSTALLED ONLY,
PANICS WITH INT. RAIL & OFFSET WIRE PULLS.

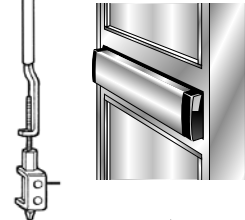

PART NO.	INSTALLED	(-1) Clear	(-2) Dk.Brnz.
64-8475-	8475 – Mortised		
64-8675-	8675 – Concealed Rod		

REMOVABLE MULLION

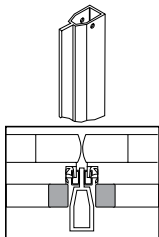

PART NO.	INSTALLED Use with Medium or Wide Stile Door	(-1) Clear	(-2) Dk.Brnz.
64-RM7-	Removable Mullion to 7'0" installed by Rebco		
64-RM8-	Removable Mullion to 8'0" installed by Rebco		

PANIC OPTIONS



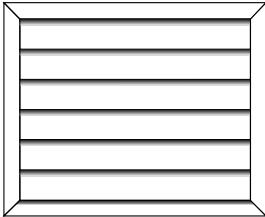

List

Cylinder Dogging in Push Bar	
Lever Trim at Exterior	



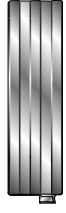

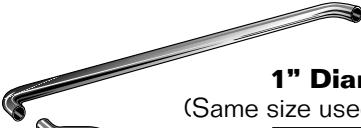

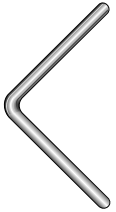
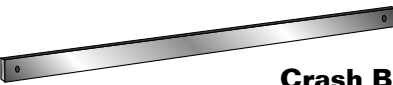
CUSTOM ADD-ONS

PART #	DESCRIPTION	(-1) CLEAR	(-2) DK. BRONZE	(-4) WHITE	(-5) BLACK
.25DF-SMP	1/4" Double Faced Anodized Panel Smooth Finish .040 sheet both sides. Minimum 2 sq. ft.				
150DF-SMP	1-1/2" Double Faced Anodized Panel Smooth Finish .040 sheet both sides. Minimum 2 sq. ft.				
.25DF-STP	1/4" Double Faced Anodized Panel Stucco Finish .040 sheet both sides. Minimum 2 sq. ft.			N/A	N/A
150DF-STP	1-1/2" Double Faced Anodized Panel Stucco Finish .040 sheet both sides. Minimum 2 sq. ft.			N/A	N/A
.25DF-PP	1/4" Double Faced Painted Panel Textured Face Sheets. Minimum 2 sq. ft.				N/A
1.00DF-PP	1" Double Faced Painted Panel Textured Face Sheets. Minimum 2 sq. ft.				N/A
41-TRM	Top Door Rail Modification				
41-BRM	Bottom Door Rail Modification				
41-7BR	Add for Installation of 7" Bottom Rail on Narrow Stile Door In Door in Lieu of Regular Rail				
41-10BR-N	10" Bottom Rail on Narrow Stile Door				
41-10BR-AO	10" Bottom Rail on Medium or Wide Stile Door				
41 - LVRA	<p>Louver 1-1/2" louver in 1-3/4" wide channel frame. Fabricated & installed by REBCO in a REBCO door.</p> 	<i>Call For Pricing</i>			

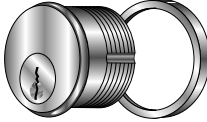

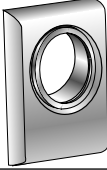
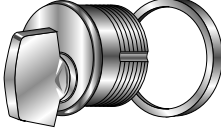
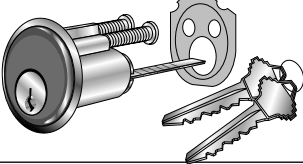
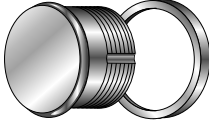
HANDLES CUSTOM HANDLES AVAILABLE UPON REQUEST

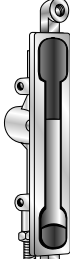
PART #	DESCRIPTION	(-1) Clear	(-2) Dark Bronze	Special	Installed
64-102	 REBCO Push Bar Assembly				
64-103	 REBCO Pull Handle 12" Long – 10 3/8" C/L				
64-106	 Hallet Pulls per set Available Through Door or Glass Mounting – 8" C/L Handle 16" overall in length				
64-109	 1" Diameter Wire Push (Same size used on NS, MS, WS doors)				
64-108	 1" Diameter Wire Pull Handle 12" C/L				
64-189	1" Dia. Wire Push/Pull Assembly				
64-110	 "V" Wire Pull Handle 12" C/L			Each Back To-Back Pair	
64-126	 Crash Bars (up to 42")				

CYLINDERS

PART #	DESCRIPTION	(-1) Clear	(-2) Dark Bronze	Special	INST
64-321	 <p>REBCO Solid Brass Mortise Cylinder</p> <p style="text-align: right;">Single</p>				
64-322	 <p>15/16" Depth (Also used with A.R. 8400 & 8600 Panics)</p> <p style="text-align: right;">Pair</p>				
64-ESC	 <p>Escutcheon Used on 8600 Panics</p>				
64-323	 <p>Solid Brass Thumb Turn Cylinder 15/16" Depth</p>				
64-324	 <p>Solid Brass Rim Cylinder 15/16" Depth Used with Dor-O-Matic Panics</p>				
64-325	 <p>Dummy Cylinder 15/16" Depth</p>				
64-BWC	 <p>Arrow Mortise or Rim Cylinder with IC Core (Includes Construction Core)</p>				
64-330	 <p>Complete Flush Bolt with Rod</p>				
64-331	 <p>Cylinder Operated Flush Bolt with Cylinder</p>				
64-332	<p>Installed Face Mounted Flush Bolts</p>				





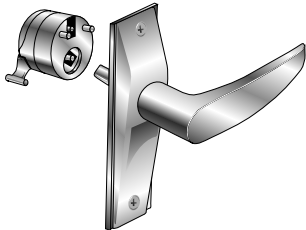
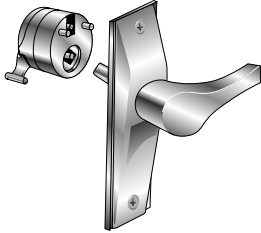
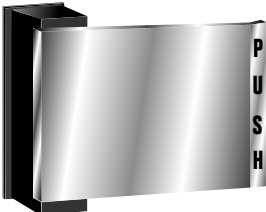
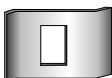
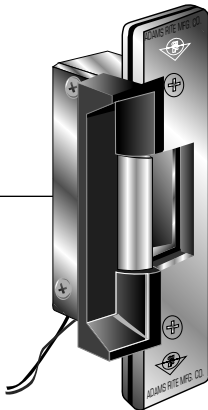

LOCKS

PART #	DESCRIPTION	(-1) Clear	(-2) Dark Bronze	Special	INST
64-301	 <p>Adams Rite Maximum Security Lock 1-1/8" B.S.</p>				
64-302	<p>With Face Plate. No Cylinders Included.</p> <p>1-1/2" B.S.</p>				
64-303	 <p>M.S. + 1890 Hook Lock + Latch Lock 1-1/8" B.S.</p>				
64-304	<p>With Face Plate & 1893 Strike. No Cylinder or Lever Handles Included.</p> <p>Locks are handed</p> <p>1-1/2" B.S.</p>				
64-307	 <p>Adams Rite Short Throw Lock 1-1/8" B.S.</p> <p>Includes Face Plate. No Cylinders Included. Only 1-1/8" B.S. in stock.</p> <p>1-1/2" B.S.</p>				
64-SLL	Special Location of M/S or Latch Lock				
64-602	Supply and Install Extra M/S Lock & 2 Cylinders – 1-1/8" B.S.				
64-604	Supply and Install Extra M/S Lock & 2 Cylinders – 1-1/2" B.S.				
64-BRL	Supply and Install Deadbolt in Top or Bottom Rail				
64-2PL	Supply and Install 2 Point Dead Lock with Cylinder				
64-3PL	Supply and Install 3 Point Dead Lock with Cylinder				



LOCK HANDLES CUSTOM HANDLES AVAILABLE UPON REQUEST

PART #	DESCRIPTION	(-1) Clear	(-2) Dark Bronze	Special	INST
64-308	 <p>Latch Lock (Handed) 1-1/8" B.S.</p>				
64-309	<p>With Face Plate No Cylinder No Levers or Paddles incl.</p> <p>1-1/2" B.S.</p>				
64-310	 <p>Lever Handle (with Cam) For Latch Lock</p>				
64-311	 <p>Short Lever Handle (with Cam) For Latch Lock</p>				
64-312	 <p>Push or Pull Paddle Swing of Door Needed</p>				
64-313	 <p>Regular Latch Lock Strike</p>				
64-313R	<p>Retrofit Latch Lock Strike Used when replacing MS Lock with Latch Lock</p>				
64-314	 <p>Standard 24 Volts AC</p> <p>Adams Rite Electric Release</p> <p>Standard 24 Volts AC</p> <p>Adams Rite Electric Release for C.O.C. application</p> <p>16 Volts AC</p>				
64-315					
64-316					
64-317					





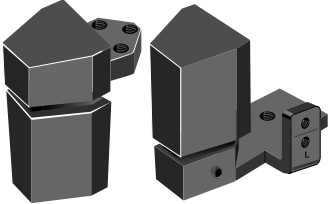
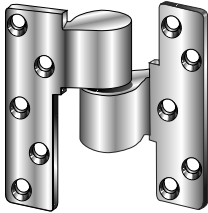
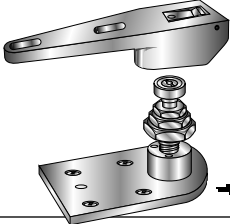
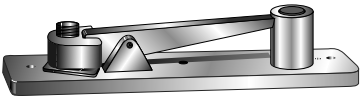

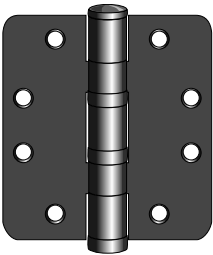
LATCH & LEVER LOCKS

PART #	DESCRIPTION	(-1) Clear	(-2) Dark Bronze	Special	INST
64-318L	 Cylindrical Leverset Passage Function				
64-318-OL	 Dummy Leverset Double Dummy Levers (No latching mechanism)				
64-319L	 Cylindrical Leverset Entrance Function				
64-LLE	Supply & Install Latch Lock, Lever Cylinder & Electric Release (24V)				
64-LPE	Supply & Install Latch Lock, Paddle, Cylinder & Electric Release (24V)				
64-LLS	Supply & Install Latch Lock, Lever, Cylinder & Latch Lock Strike				
64-LPS	Supply & Install Latch, Paddle, Cylinder & Latch Lock Strike				
64-TSU	Deadbolt/Latch Combo (MS1890) Supply & Install – Latch Lock with 2 Levers, MS Lock, 2 cylinders and MS 1890 Strike				
64-SMPLX	SIMPLEX 3000 Pushbutton Combo Lockset (Not including Latchlock/Paddle)				
41-050	REBCO Astragal (installed) For Pair of Doors				
41-051	REBCO Astragal (installed) For Single Door & Frame				
64-318	 Knob Lock Passage Function				
64-318-0	 Dummy Knob Lock Double Dummy Knobs (No latching mechanism)				
64-319	 Knob Lock Entrance Function				

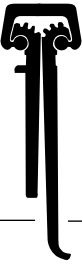
PIVOTS & BUTTS

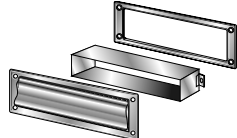
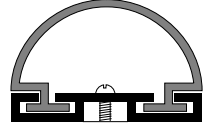
PART #	DESCRIPTION	(-1) Clear	(-2) Dark Bronze	Special	INST
64-340	 <p>REBCO Complete Set of Offset Pivots (Handed) Sold in Sets Only</p>				
64-341	 <p>REBCO Intermediate Pivot Full Mortised – Handed</p>				
64-383D 64-383J	Intermediate Pivot Back-up Plate - Door or Jamb				
64-344	 <p>Center Hung Bottom Pivot Set Door & Threshold Portion Used in lieu of threshold only.</p>				
64-346	 <p>Center Hung Top Pivot – Frame Portion “Walking Beam”</p>				
64-345	 <p>Center Hung Top Pivot – Door Portion Channel with Bushing</p>				
64-381	 <p>4-1/2" x 4" B.B. Butts (Non-Ferrous) Standard (Non-Removable Pin)</p>				
64-SBL	Special Location – Pair of Butts				
64-DMB	Double Mortise Butts – Door Only – Per Pair				
64-382D 64-382J	Butt Back-up Plate – Door or Jamb				

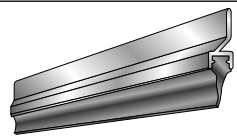
MISCELLANEOUS

PART #	DESCRIPTION	(-1) Clear	(-2) Dark Bronze	Special	Installed
64-384FM-1 64-384FMX-1 64-384FMXL-1	 <p>Continuous Full Mortise Hinge Surface Mounted</p> <p>83" height 95" height 120" height Above 8'</p>				
64-384FS-1 64-384FSX-1 64-384FSXL-1	 <p>Continuous Full Surface Hinge Surface Mounted</p> <p>83" height 95" height 120" height Above 8'</p>				
	<p>Other Continuous Hinges Are Available Call for Price & Lead Time. Add 30% for H.D. Cont. Hinges</p>				
64-450	 <p>Drop Arm Door Holder</p>				
64-460	 <p>8-3/4" x 3" Mail Slot With Sleeve (7-1/4" x 2-1/4")</p>				
41-100	 <p>Finger Guard 7'0" Long (for CH door only)</p>				
42-079	 <p>Crash Chains 25-1/2"</p>				
42-080	 <p>Door Bottom Sweep 42" Long with screws</p>				
68-103	 <p>Touch Up Spray Paint 16 oz.</p> <ul style="list-style-type: none"> • Clear (-1) • Bronze Anodized (-2) • White Paint (-4) • Black Anodized (-5) 				

INSTALLATION OF HARDWARE SUPPLIED BY OTHERS

NOTE: Hardware and Templates must be supplied for prep and/or installation by REBCO.
We cannot work from templates alone. Customer must supply hardware.

PART #	ITEM		FABRICATE TO DOOR	FABRICATE TO DOOR
64-001	Top or Bottom Offset Pivot	Rixson or Similar		
64-002	Intermediate Pivot	M19 or Similar		
64-003	Top Center Hung Pivot (Walking Beam)			
64-004	Bottom Center Hung Pivot	Narrow Stile Door Medium or Wide Stile Door		
64-005	Butt Hinge Installation - Other than Stock Size	(4-1/2" x 4-1/2", 5" x 5", etc.)		
64-006	Continuous Hinge (Marker, Roton, Pemko, Zero, Etc.)	Surface Mounted Mortised (incl. under sizing door)	SEE PAGE 28	
64-007	Install COC Arm in Door	Center Hung		
64-008	Install COC Arm in Door	Offset		
64-009	Install COC in Header			
64-0011	Surface Overhead Holder			
64-0012	Concealed Overhead Holder			
64-0013	Install Header for Automatic Closer			
64-0014	Install Floor Closer Arm in Door	Center Hung		
64-0015	Install Floor Closer Arm in Door	Offset		
64-0016	Prepare 7" Threshold with cutouts for Floor Closer	up to 42"		
64-0017	Prepare 7" Threshold with cutouts for Floor Closer	up to 84"		
64-0018	Deadlock (M.S. Lock) – Similar to Adams Rite			
64-0019	Latchlock – Similar to Adams Rite			
64-0020	Locks which require Special Cutouts – Price determined upon review of lock			
64-0021	Knob Locks – Similar to Kwikset			
64-0022	Full Mortise Lockset – Corbin or similar			
64-0023	Dummy Knob Lock			
64-0024	Unicorn or Simplex Lock			
64-0025	Flush Bolts – Regular or Face Mounted – EACH			
64-0026	Cylinder Operated Flushbolts – EACH			
64-0027	Back to Back Thru Bolt Handles – Push/Pull Combo or Pair Pull			
64-0028	Kick Plate – Pre-drilled – (per door – 2 plates)			
64-0029	Concealed Panic – no cylinder outside			
64-0030	Concealed Panic – with cylinder outside			
64-0031	Rim Panic – no cylinder outside			
64-0032	Rim Panic – with cylinder outside			
64-0033	Mortised Panic			
64-0034	Removable Mullion			
64-0035	Special Outside Trim for Panics			